

Comp 555 - BioAlgorithms - Spring 2022

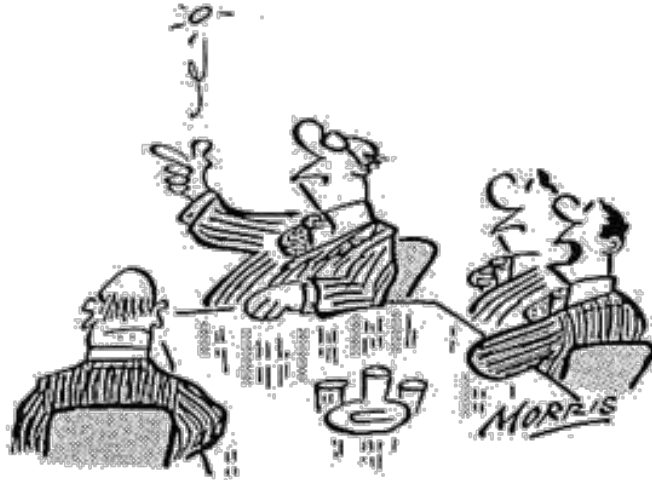
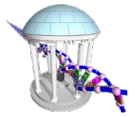

This is the improved market model from the finance department... it works 50% of the time.

- **PROBLEM SET #5 IS DUE NEXT THURSDAY 4/14**
- **WHAT IS THE MOST LIKELY SEQUENCE TO HAVE EXHIBITED A GIVEN SET OF ATTRIBUTES**
- **STATES THAT EMIT SYMBOLS**

Hidden Markov Models

Dinucleotide Frequency



Consider all dimers in a sequence:

{AA,AC,AG,AT,CA,CC,CG,CT,GA,GC,GG,GT,TA,TC,TG,TT}

Given 4 nucleotides, each with a probability of occurrence of $\approx 1/4$, one would expect that the probability of occurrence of any given dinucleotide is $\approx 1/16$.

However, the frequencies of dinucleotides in DNA sequences vary widely.

In particular, CG is typically underrepresented (frequency of CG is typically $\ll 1/16$)

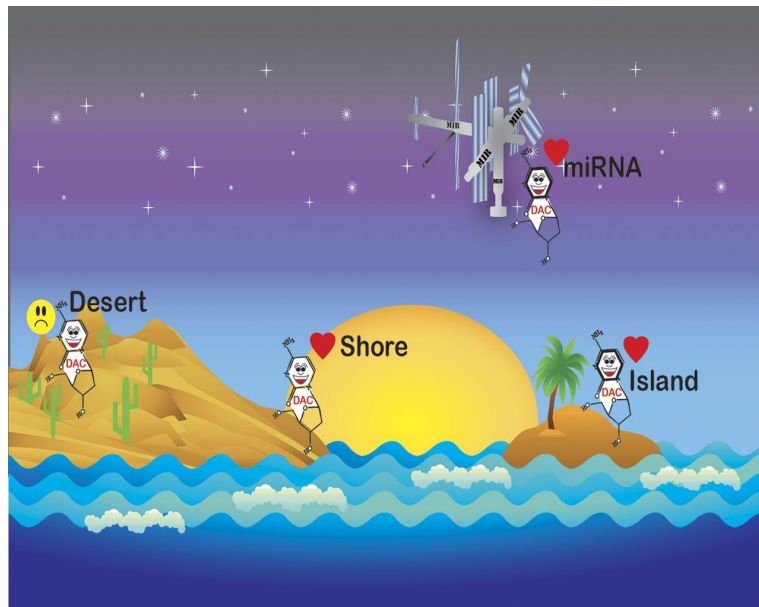

Example

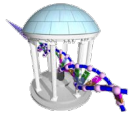

- From a 291829 base sequence from the human genome

AA	0.120214646984	GA	0.056108392614
AC	0.055409350713	GC	0.037792809463
AG	0.068848773935	GG	0.043357731266
AT	0.083425853585	GT	0.046828954041
CA	0.074369148950	TA	0.077206436668
CC	0.044927148868	TC	0.056207766218
CG	0.008179475581	TG	0.063698479926
CT	0.066857875186	TT	0.096567155996

- Expected value is 0.0625
- CG is 7 times smaller than expected
- Actually the dinucleotides "AT", "CG", "GC", and "TA" are undercounted. Why?



Why so few CGs?

- CG is the least frequent dinucleotide because C in CG is easily *methylated*. And, methylated Cs are easily mutated into Ts.

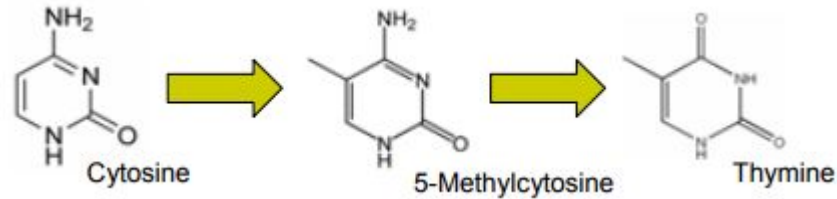

- However, methylation is suppressed around genes and transcription factor binding sites
- So, CG appears at relatively *higher* frequency in these important areas
- These localized areas of higher CG frequency are called **CG-islands**
- Finding the CG islands within a genome is among the most reliable gene finding approaches

CG Island Analogy



The CG islands problem can be modeled by a toy problem named "*The Fair Bet Casino*" where the outcome of a casino game is determined by coin flips with two possible outcomes: **H**eads or **T**ails

However, there are two different coins:

A **F**air coin: where **H**eads and **T**ails occur with same probability $1/2$.

A **B**iased coin: which lands **H**eads with prob. $3/4$,
and **T**ails with prob. $1/4$.



The "Fair Bet Casino"



Thus, we define the probabilities:

- $P(H|Fair) = 1/2, P(T|Fair) = 1/2$
- $P(H|Bias) = 3/4, P(T|Bias) = 1/4$

Also, the house doesn't want to get caught switching between coins, so they do so infrequently. Thus, swaps between Fair and Biased coins occur with probability $1/10$.



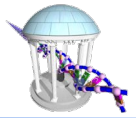

Fair Bet Casino Problem

Input: A sequence $x = x_1, x_2, x_3, \dots, x_n$ of observed coin tosses made by some combination of the two possible coins (**F** or **B**).

Output: A sequence $\pi = \pi_1, \pi_2, \pi_3, \dots, \pi_n$, with each π_i being either **F** or **B** indicating that x_i was the result of tossing the Fair or Biased coin respectively.



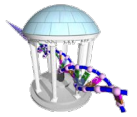

Problem Subtleties

- Any observed outcome of coin tosses *could* have been generated by *any combination* of coin exchanges
- However, all coin-exchange combinations are not equally likely.

Tosses: T H H H H

Coins1: F F F F F $P(\text{Tosses}|\text{Coins1}) = 1/2 \ 1/2 \ 1/2 \ 1/2 \ 1/2 = 1/32 = 0.03125$

Coins2: B B B B B $P(\text{Tosses}|\text{Coins2}) = 1/4 \ 3/4 \ 3/4 \ 3/4 \ 3/4 = 81/1024 = 0.0791$

Coins3: F F B B B $P(\text{Tosses}|\text{Coins3}) = 1/2 \ 1/2 \ 3/4 \ 3/4 \ 3/4 = 81/256 = 0.3164$

- We ask, "What **coin-exchange combination** has the highest probability of generating the observed series of tosses?"
- The coin tosses are a signal, and figuring out the most likely coin-exchange sequence is a *Decoding Problem*

Let's consider the extreme cases



Suppose that the dealer *never* exchanges coins.

Some definitions:

- $P(x|Fair)$: prob. of generating the x using the Fair coin.
- $P(x|Biased)$: prob. of generating x using the Biased coin.

We can compute the probability of any set of tosses under these two given conditions, and ask which case was more likely.



$P(x|\text{fair coin})$ vs. $P(x|\text{biased coin})$



And the expressions look like:

$$P(x|Fair) = P(x_1 \dots x_n|Fair) = \prod_{i=1,n} p(x_i|Fair) = \left(\frac{1}{2}\right)^n$$

$$P(x|Biased) = P(x_1 \dots x_n|Biased) = \prod_{i=1,n} p(x_i|Biased) = \left(\frac{3}{4}\right)^k \left(\frac{1}{4}\right)^{n-k} = \frac{3^k}{4^n}$$

Where k is the number of Heads observed in x

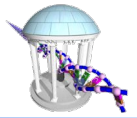

$$P(x|\text{fair coin}) = P(x|\text{biased coin})$$

When is a sequence equally likely from *either* the Fair or Biased coin?

$$P(x|Fair) = P(x|Biased)$$

$$\left(\frac{1}{2}\right)^n = \frac{3^k}{4^n}$$

$$2^n = 3^k$$

$$n = k \log_2 3$$

When $k = \frac{n}{\log_2 3}$ ($k \approx 0.63n$)

So, when the number of heads over a contiguous sequence of tosses is greater than 63% the dealer is most likely used the biased coin.



Log-odds Ratio

- We can define a *log-odds ratio* as follows:

$$\begin{aligned}\log_2 \left(\frac{P(x|Fair)}{P(x|Biased)} \right) &= \sum_{i=1}^k \log_2 \left(\frac{P(x_i|Fair)}{P(x_i|Biased)} \right) \\ &= n - k \log_2 3\end{aligned}$$

- The log-odds ratio is a means (threshold) for deciding which of two alternative hypotheses is most likely
- "Zero-crossing" measure:
 - a. If the log-odds ratio is > 0 then the numerator (Fair coin) is more likely
 - b. if the log-odds ratio is < 0 then the denominator (Biased coin) is more likely
 - c. They are equally likely if the log-odds ratio = 0

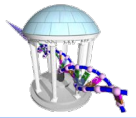

Log-odds Ratio over a sliding window

Given a sequence of length n , consider the log-odds ratio of a sliding window of length $w \ll n$

$$x_1, x_2, x_3, x_4, x_5, x_6, x_7, x_8, x_9, \dots, x_n$$

```
In [7]: import numpy
import matplotlib.pyplot as plot
%matplotlib inline

rolls = "HHHHTHHHHHHHHHHHHHHHTHHHHHTHHHTTHTHHHHHTHTHTHTHTTHTHHHTHTTTHTTTHTT"

windows = [7, 9, 11, 13]
slope = numpy.log2(3)
yplots = [[w - slope*rolls[i:i+w].count('H') for i in range(len(rolls)-w+1)] for w in windows]

fig, ax = plot.subplots(figsize=(16,5))
plot.title("Window size = %s" % windows)
plot.hlines(0, 0, len(rolls), linestyle='dotted')
for i, y in enumerate(yplots):
    x = range(windows[i]//2, windows[i]//2+len(y))
    plot.plot(x,y, label=str(windows[i]))
plot.legend()
ax.set_xticks([i for i in range(len(rolls))])
plot.vlines([27,56], -8, 8, linestyle='dashed')
result = ax.set_xticklabels([c for c in rolls])
```

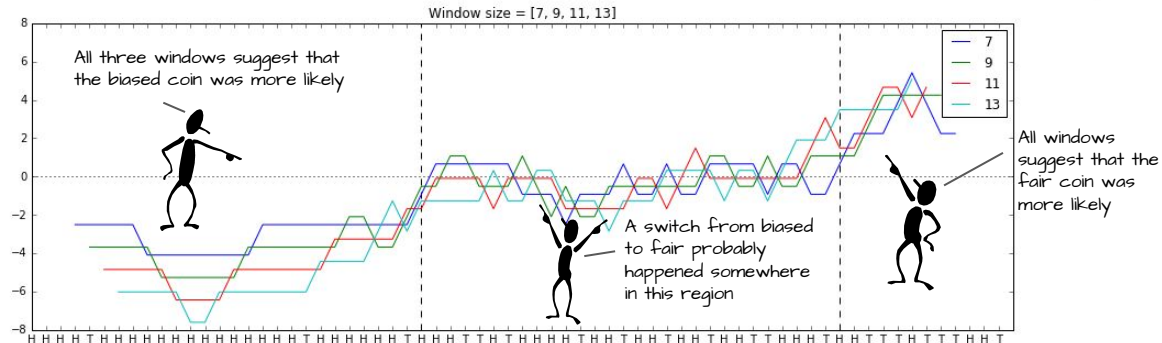

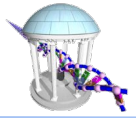

Disadvantages of windowed Log-odds

- How to choose an appropriate window size (i.e. length of CG-island). It may not be known in advance.
- Different window sizes may classify the same position differently.
- What about the rule that they don't swap out the coins frequently?
- Considering windows around ten isn't really sufficient.

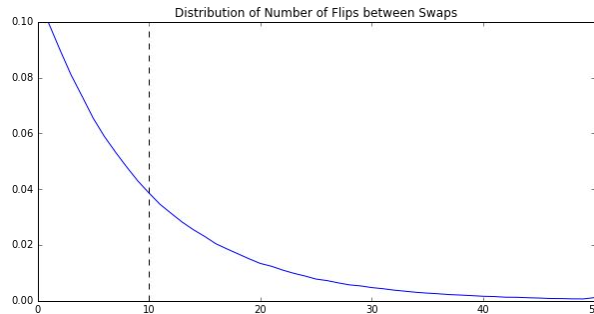

SINGLE SLIDER WINDOW STANDARD SIZES

moderniz[®]

ROUGH OPENING WIDTH

ROUGH OPENING HEIGHT	ROUGH OPENING WIDTH				
	36"	48"	60"	72"	84"
24"	 3020	 4020	 5020	 6020	 7020
36"	 3030	 4030	 5030	 6030	 7030
48"	 3040	 4040	 5040	 6040	 7040
60"	 3050	 4050	 5050	 6050	 7050



Key Aspects of the Problem

- There is an unknown or *hidden* state for each observation (Was the coin the Fair or Biased?)
- Outcomes are modeled probabilistically:

$$\begin{aligned} \blacksquare P(H|Fair) &= \frac{1}{2}, & P(T|Fair) &= \frac{1}{2} \\ \blacksquare P(H|Bias) &= \frac{3}{4}, & P(T|Bias) &= \frac{1}{4} \end{aligned}$$

- *Transitions* between states are modeled probabilistically:

$$\begin{aligned} \blacksquare P(\pi_i = Bias \mid \pi_{i-1} = Bias) &= a_{BB} = 0.9 \\ \blacksquare P(\pi_i = Bias \mid \pi_{i-1} = Fair) &= a_{FB} = 0.1 \\ \blacksquare P(\pi_i = Fair \mid \pi_{i-1} = Bias) &= a_{BF} = 0.1 \\ \blacksquare P(\pi_i = Fair \mid \pi_{i-1} = Fair) &= a_{FF} = 0.9 \end{aligned}$$

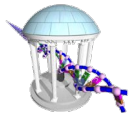

Hidden Markov Model (HMM)

- A generalization of this class of problem
- Can be viewed as an abstract machine with k hidden states that emits symbols from an alphabet Σ .
- Each state emits outputs with its own probability distribution, and the machine switches between states according to some other probability distribution.
- While in a certain state, the machine makes 2 decisions:
 - What symbol from the alphabet Σ should I emit?
 - What state should I move to next?

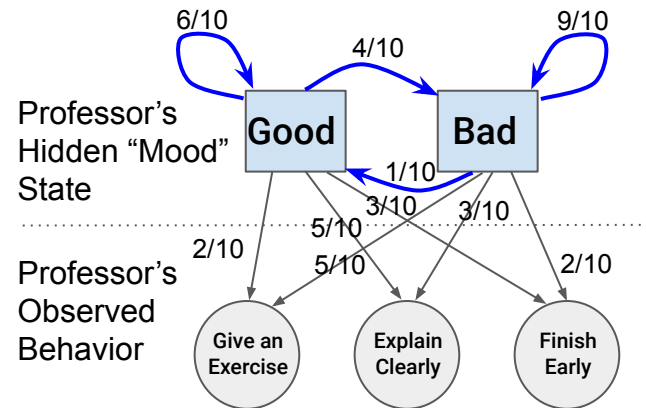

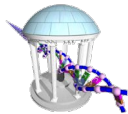

Why “Hidden”?

- Observers see the emitted symbols of an HMM, but can't see which state the HMM is currently in.
- Thus, the goal is to infer the *most likely series of hidden states* given a sequence of emitted symbols.

Observation: **HHHTHTHHTTTTHTHTHTHHHTHTHTHT**
Hidden State: **BBBFFFFFFFFFFFFFFFFFBBBFFFFFFFF?**



HMM Parameters



- Σ : set of emission characters. (Observable)

Example: $\Sigma = \{0, 1\}$ for coin tossing

- $\Sigma = \{\text{Heads, Tails}\}$
 - $\Sigma = \{1, 2, 3, 4, 5, 6\}$ for dice tossing
-
- **Q**: set of hidden states, emitting symbols from Σ . (Hidden)
 - $Q = \{\text{Fair, Bias}\}$ for coin tossing
 - $Q = \{\text{Good Mood, Bad Mood}\}$

What makes the model Markov?

All outcomes about what is emitted and what the next state will be depend entirely on the current state, in contrast to a series of past outputs and/or states

HMM for Fair Bet Casino



- The Fair Bet Casino in HMM terms:
 - $\Sigma = \{0, 1\}$ (0 for Tails and 1 Heads)
 - $Q = \{F, B\}$ – F for Fair & B for Biased coin
- Transition Probabilities **A**, Emission Probabilities **E**

What makes the model Markov?

Such models can be described using tables. Emission-- what is output based on the current state, Transition-- what is the next state based on the current state.

A	Fair	Biased
Fair	9/10	1/10
Biased	1/10	9/10

E	Tails(0)	Heads(1)
Fair	1/2	1/2
Biased	1/4	3/4

HMM as a Graphical Model

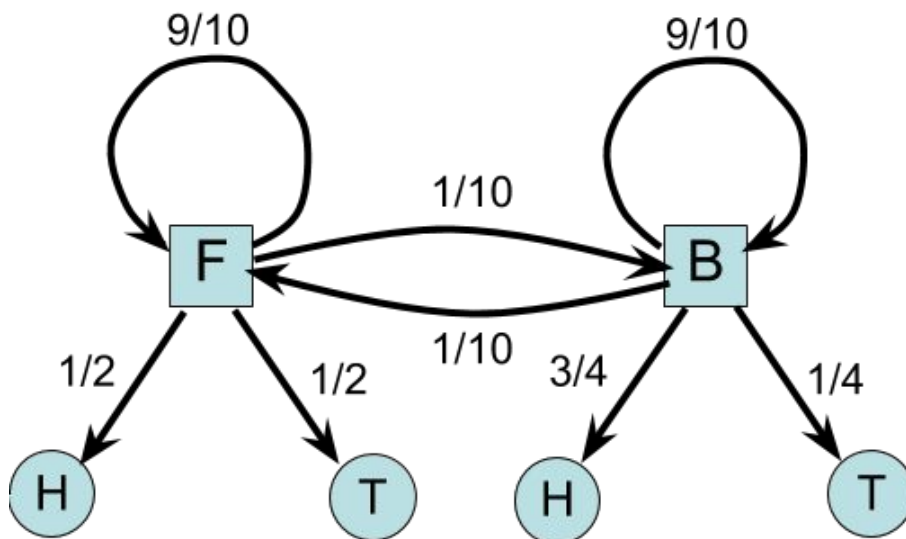

Directed graph with two types nodes and two types of edges

- hidden states are shown as squares
- emission outputs are shown as circles
- transition edges
- emission edges

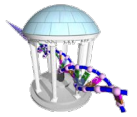

Hidden Paths

- A path $\pi = \pi_1 \dots \pi_n$ in the HMM is defined as a sequence of hidden states.
- Consider
 - path $\pi = \text{FFFBBBBBFFF}$
 - sequence $x = 01011101001$

x	=	0	1	0	1	1	1	0	1	0	0	1
π	=	<i>F</i>	<i>F</i>	<i>F</i>	<i>B</i>	<i>B</i>	<i>B</i>	<i>B</i>	<i>B</i>	<i>F</i>	<i>F</i>	<i>F</i>
$P(x_i \pi_i)$		$\frac{1}{2}$	$\frac{1}{2}$	$\frac{1}{2}$	$\frac{3}{4}$	$\frac{3}{4}$	$\frac{3}{4}$	$\frac{1}{4}$	$\frac{3}{4}$	$\frac{1}{2}$	$\frac{1}{2}$	$\frac{1}{2}$
$P(\pi_i \rightarrow \pi_{i+1})$		$\frac{9}{10}$	$\frac{9}{10}$	$\frac{1}{10}$	$\frac{9}{10}$	$\frac{9}{10}$	$\frac{9}{10}$	$\frac{9}{10}$	$\frac{1}{10}$	$\frac{9}{10}$	$\frac{9}{10}$	

- What is the probability of the given path (FFFBBBBBFFF)?
- What is the probability of the given path FFFBBBBBFFF emitting the sequence 01011101001?

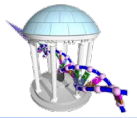

$P(x|\pi)$ calculation

- $P(x|\pi)$: Probability that sequence x was generated by the path π :

$$\begin{aligned} P(x|\pi) &= \prod_{i=1}^n P(x_i|\pi_i) \cdot P(\pi_i \rightarrow \pi_{i+1}) \\ &= \prod_{i=1}^n E_{\pi_i, x_i} \cdot A_{\pi_i, \pi_{i+1}} \end{aligned}$$

- How many such paths exist? 2^n
- What algorithmic approach would you use to find the best path?
 - Branch and Bound?
 - Divide and Conquer?
 - Dynamic Programming?

Decoding Problem

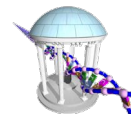

Finding the optimal path in a graph is equivalent to a classical problem of decoding a message using *constellations*. This is very commonly used when a discrete set of symbols is encoded for transport over an analog medium (e.x. modems, wired internet, wireless internet, digital television).

A simple binary coding does not make good use of the dynamic range of a digital signal, however, if you put the codes too close noise becomes a problem.

- **Goal:** Find an optimal hidden path of state transitions given a set of observations.
- **Input:** Sequence of observations $x = x_1 \dots x_n$ generated by an HMM $M(\Sigma, Q, A, E)$
- **Output:** A path that maximizes $P(x|\pi)$ over all possible paths π .

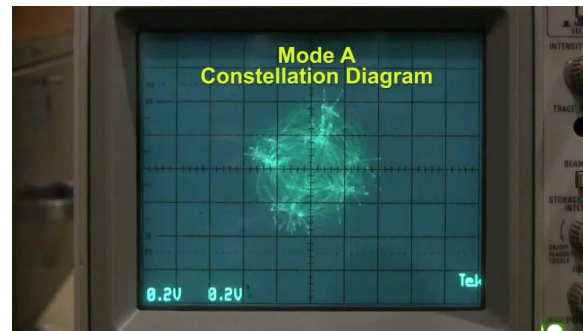

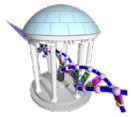

How do we solve this?

- Brute Force approach:
 - Enumerate every possible path
 - Compute $P(x_{1..n}|\pi_{1..n})$ for each one
 - Keep track of the most probable path
- A better approach:
 - Break any path in two parts, $P(x_{1..i}|\pi_{1..i}), P(x_{i..n}|\pi_{i..n})$
 - $P(x_{1..n}|\pi_{1..n}) = P(x_{1..i}|\pi_{1..i}) \times P(x_{i..n}|\pi_{i..n})$
 - Will less than the highest $P(x_{1..i}|\pi_{1..i})$ ever improve the total probability?
 - Thus to find the maximum $P(x_{1..n}|\pi_{1..n})$ we need find the maximum of each subproblem $P(x_{1..i}|\pi_{1..i})$, for i from 1 to n
 - What algorithm design approach does this remind you of?

Building Manhattan for Decoding



In 1967, Andrew Viterbi developed a “Manhattan-like grid” (Dynamic program) model to solve the Decoding Problem.

Every choice of $\pi = \pi_1, \pi_2, \dots, \pi_n$ corresponds to a path in the graph.

The only valid direction in the graph is eastward.

This graph has $|Q|^2(n-1)$ edges.

Where Q is the number of states and n is the path length



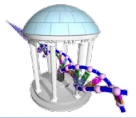

Graph of Decoding Problem

4 hidden states

Q states

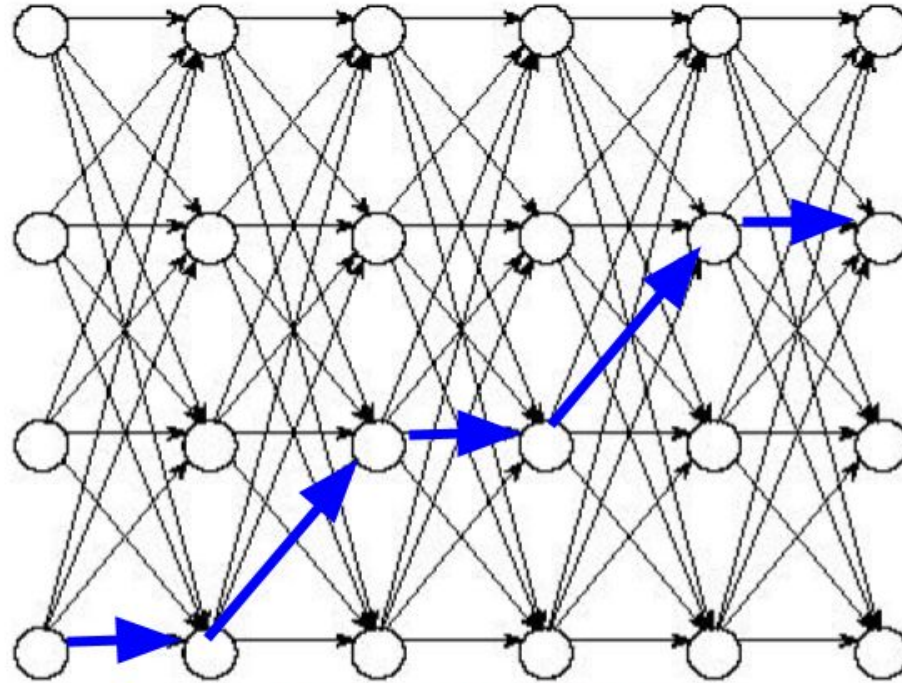

Path with greatest probability

6 output observations
 n layers



Viterbi Decoding of Fair-Bet Casino

- Each vertex represents a possible state at a given position in the output sequence
- The observed sequence conditions the likelihood of each state
- Dynamic programming reduces search space to:
 $|Q|^2 \times (n-1) = 2^2 \times 5 = 20$ from naïve $2^5 = 32$

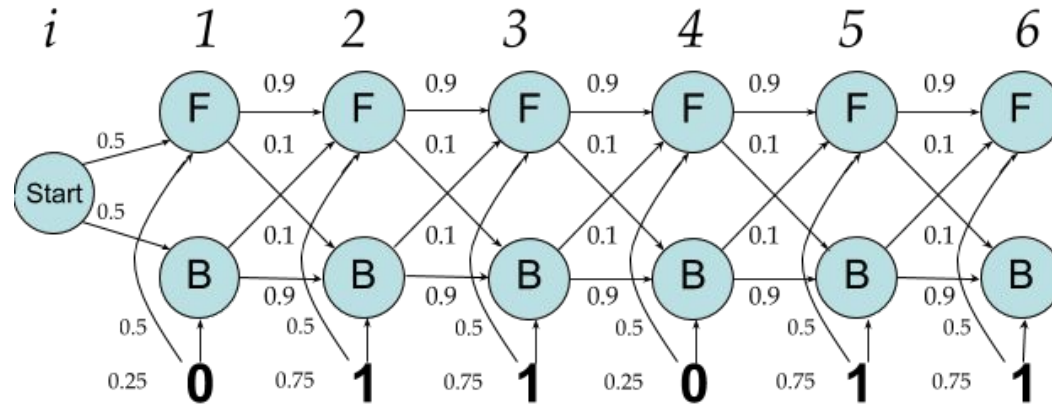

- What if $n=50$? $2^2 \times 50 = 200$ vs. $2^{50} = 1,125,899,906,842,624$



Decoding Problem Solution

- The *Decoding Problem* is equivalent to finding a longest path in the *directed acyclic graph* (DAG), where "longest" is defined as the maximum product of the probabilities along the path.

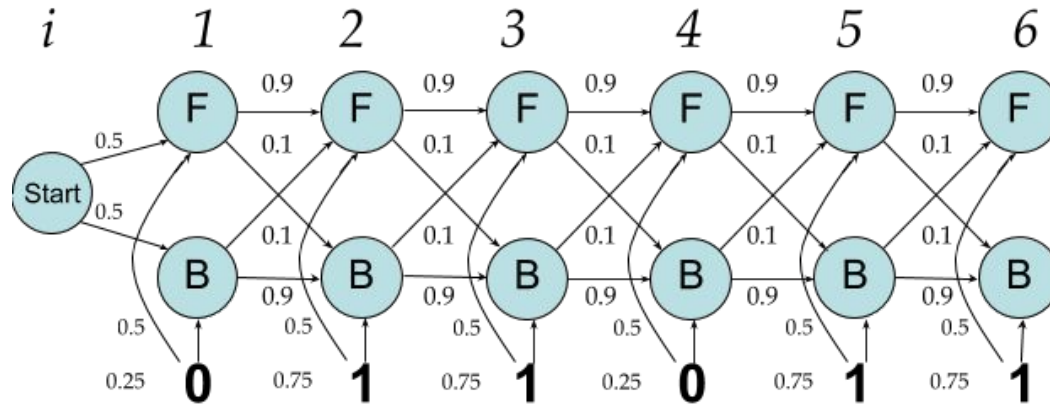

Next Time

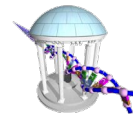

- We'll find the DP recurrence equations
- See examples and what Viterbi looks like in code
- See how truth and maximum likelihood do not always agree
- Apply to HMMs to problems of biological interest.